

EFFECTIVE:
26-MAY-11

HORIZONTAL MOTORS

TEFC- WITH STEARNS BRAKE

PRINT:
07-2665

SUPERSEDES:
11-DEC-06

FRAME: 56
BASIC TYPE: UT

SHEET:
1 OF 1

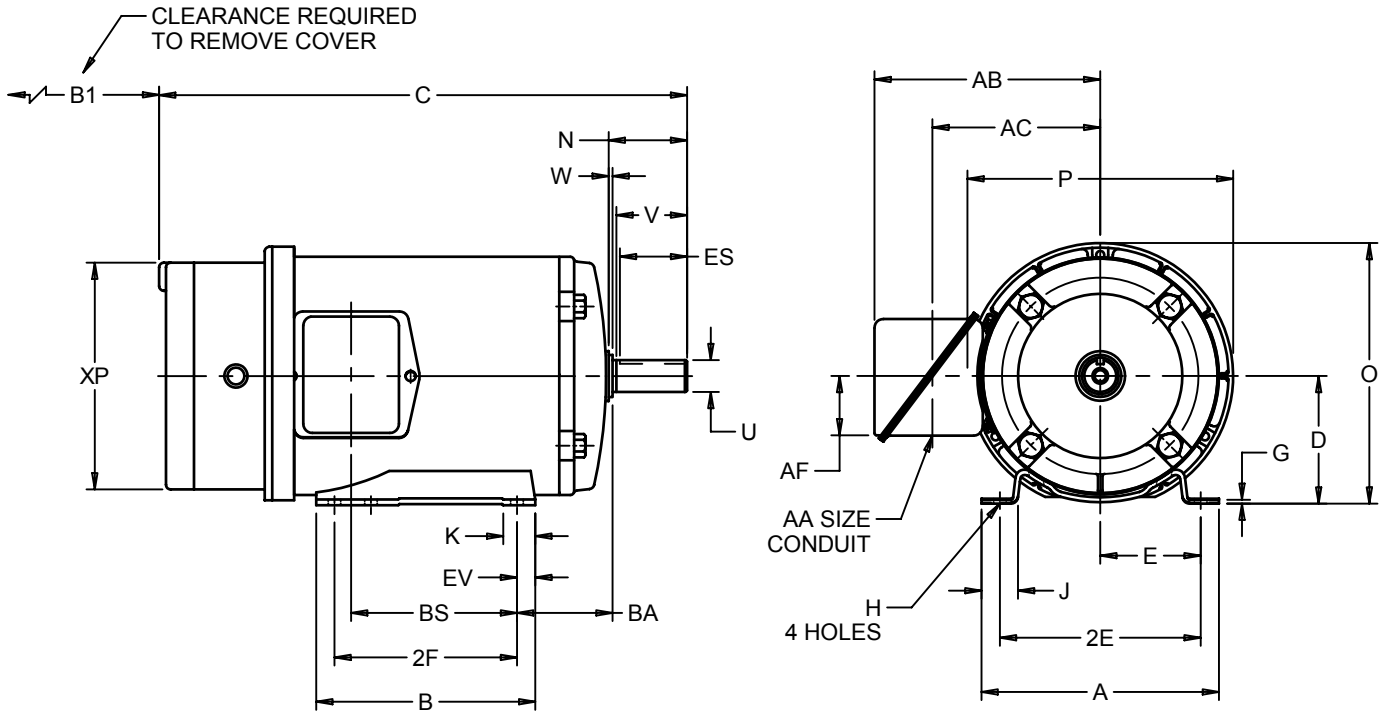

ALL DIMENSIONS ARE IN INCHES AND MILLIMETERS

UNITS	A	B	C	D	E	2E	2F	G	H	J	K	N	O	P ²
IN	6.50	4.00	17.31	3.50	2.44	4.88	3.00	.13	.34	1.63	1.06	2.22	7.47	7.28
MM	165	102	440	89	62	124	76	3	9	41	27	56	190	185

UNITS	U	V	W	AA	AB	AC	AF	BA	BS	B1	ES	EV	XP	SQ	KEY
	-.0005	MIN									MIN				
IN	.6250	1.88	.38	.75	6.00	4.34	1.06	2.75	4.38	2.94	1.41	.50	6.53	.188	
MM	15.875	48	10		152	110	27	70	111	75	36	13	166	4.78	

NOTE:
THIS PRINT IS GOOD FOR MOTORS WITH STEARNS BRAKE 56,3XX SERIES, (OPEN) ENCLOSURE RANGING FROM 1.5 THRU 15 LB. FT.

- 1: ALL ROUGH DIMENSIONS MAY VARY .25" DUE TO CASTING AND/OR FABRICATION VARIATIONS.
- 2: LARGEST MOTOR WIDTH.
- 3: TOLERANCES SHOWN ARE IN INCHES ONLY.
- 4: CONDUIT BOX MAY BE LOCATED ON EITHER SIDE OF MOTOR. CONDUIT OPENINGS MAY BE LOCATED IN STEPS OF 90° REGARDLESS OF LOCATION. STANDARD AS SHOWN WITH CONDUIT OPENING DOWN

07-2665/A

Nidec Motor Corporation
St. Louis, Missouri

INFORMATION DISCLOSED ON THIS DOCUMENT IS CONSIDERED PROPRIETARY AND SHALL NOT BE REPRODUCED OR DISCLOSED WITHOUT WRITTEN CONSENT OF NIDEC MOTOR CORPORATION



ISSUED BY
M. CHAUDHARI
APPROVED BY
R. KING

IHP_DP_NMCA (MAR-2011) SOLIDEDGE