

EFFECTIVE:
18-AUG-20

SUPERSEDES:
NEW

DIMENSION PRINT
IEC WORLD MOTOR HOSTILE DUTY B5 FLANGE
FRAME: 160
BASIC TYPE: ICTEF

PRINT:
08-1259

SHEET:
1 OF 1

DIMENSIONS ARE SHOWN IN mm

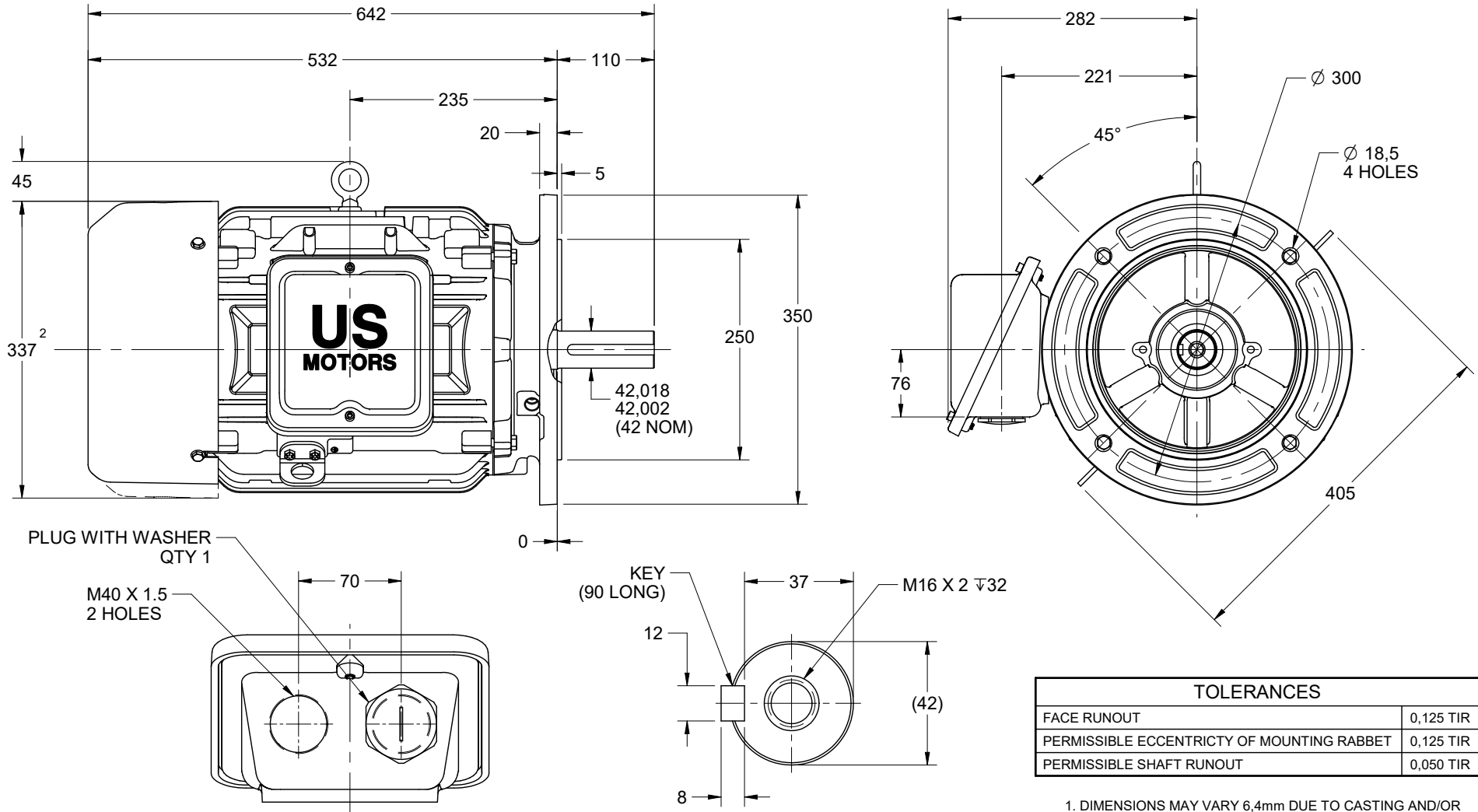

TOLERANCES	
FACE RUNOUT	0,125 TIR
PERMISSIBLE ECCENTRICITY OF MOUNTING RABBET	0,125 TIR
PERMISSIBLE SHAFT RUNOUT	0,050 TIR

1. DIMENSIONS MAY VARY 6,4mm DUE TO CASTING AND/OR FABRICATION VARIATIONS
2. LARGEST MOTOR WIDTH.
3. CONDUIT OPENING MAY BE LOCATED IN STEPS OF 90° REGARDLESS OF THE LOCATION.

08-1259/-

Nidec Motor Corporation
St. Louis, Missouri

INFORMATION DISCLOSED ON THIS DOCUMENT IS CONSIDERED PROPRIETARY AND SHALL NOT BE REPRODUCED OR DISCLOSED WITHOUT WRITTEN CONSENT OF NIDEC MOTOR CORPORATION



ISSUED BY
L. ALBELDAÑO
APPROVED BY
G. GARCIA

IHP_DP_IEC_NMCA (JAN-2018) SOLIDEDGE